

Modello model modèle Modell

	G7F4E+FG1		G7F4E+FG		G7F4E+FE1		G7F4E+FE			
bruciatori aperti open burners brûleurs ouverts Öffene Brenner	n.	2	2	n.	2	2	2	n.	2	2
	Ø mm	91,8	120,3	Ø mm	91,8	120,3	120,3	Ø mm	91,8	120,3
	kW	3	3,6	kW	3	3,6	3,6	kW	3	3,6
	Kcal/h	2.580	3.096	Kcal/h	2.580	3.096	3.096	Kcal/h	2.580	3.096
	BTU/h	10.236	12.283	BTU/h	10.236	12.283	12.283	BTU/h	10.236	12.283
bruciatori forno oven burners brûleurs four Brenner Backofen	n.	1		n.	1			n.	1	
	kW	4		kW	7,8			kW	4	
	Kcal/h	3.440		Kcal/h	6.708			Kcal/h	3.440	
	BTU/h	13.648		BTU/h	26.614			BTU/h	13.648	
forno elettrico electric oven four électrique Elektrobackofen										
	kW			kW		3,5		kW		7,5
potenza totale total heat input puissance totale Gesamtleistung	kW	17,2		kW	21			kW	13,2+7,5	
	Kcal/h	14.795		Kcal/h	18.060			Kcal/h	11.352	
	BTU/h	56.686		BTU/h	71.652			BTU/h	45.038	
consumo gas gas consumption consommation gaz Gasverbrauch	G 30/G31	kg/h	1,3	G 30/G31	kg/h	1,6		G 30/G31	kg/h	1
	G20	m ³ /h	1,8	G20	m ³ /h	2,2		G20	m ³ /h	1,4
	G25	m ³ /h	2,1	G25	m ³ /h	2,5		G25	m ³ /h	1,6
connessione gas gas connection raccordement gaz Gasanschluss		3/8" G			1/2" G				3/8" G	
connessione elettrica electric connection branchement électrique elektrischer Anschluss										
						V 230 - 240 ~				V 230 - 240 ~
optional option Zubehör										
	accens. el. Fuochi - burners el. ign.			accens. el. Fuochi - burners el. ign.				accens. el. Fuochi - burners el. ign.		
	allum. el. brûleurs			allum. el. brûleurs				allum. el. brûleurs		
	Brennern elekt. Zündung			Brennern elekt. Zündung				Brennern elekt. Zündung		
dim. camera forno cavity dimensions dimensions chambre Abmessung Innenraum	mm	620x390x295h		mm	685x550x295h			mm	685x550x295h	
	n.	4 x 1/1 GN		n.	4 x 2/1 GN			n.	4 x 2/1 GN	
		(n. 4 x 600x400)								
dotazione griglie grids supplies fourniture de grilles Mitgelieferte Roste	n.	1 x 600x400		n.	1 x 2/1 GN			n.	1 x 2/1 GN	
peso totale total weight pois total Gesamtgewicht	kg	95		kg	102			kg	94	
cubatura cubic volume volume Volumen	m ³	0,85		m ³	0,85			m ³	0,85	

Macros 700 cooking ranges

G7F4E+FG1
G7F4E+FG

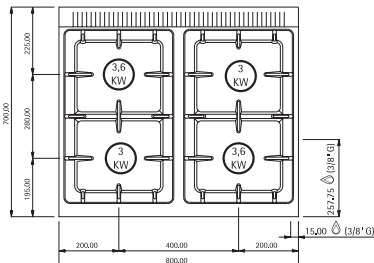
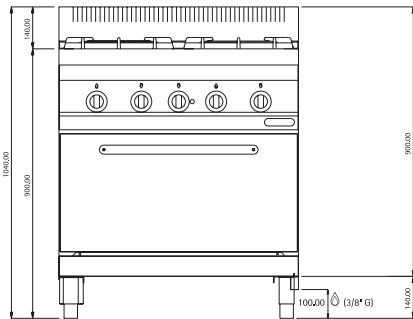

G7F4E+FE1
G7F4E+FE

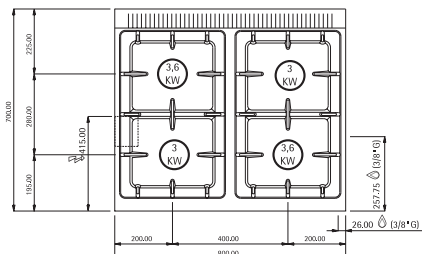
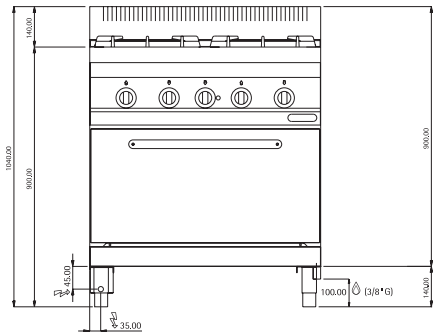

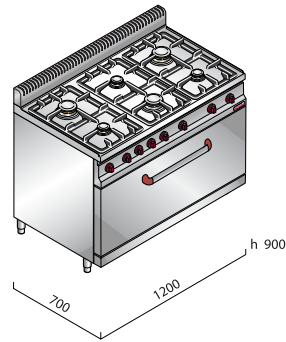
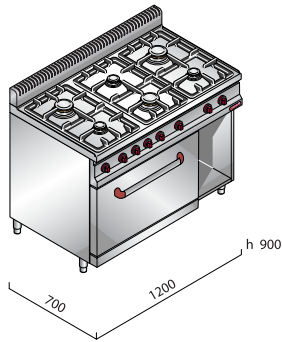
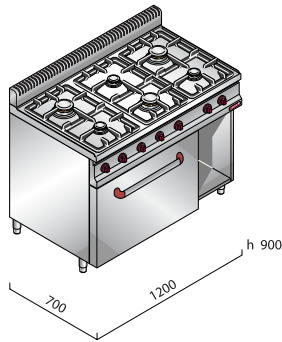

BERTO'S SPA®

Macro 700 cooking ranges

Modello model modèle Modell

bruciatori aperti
open burners
brûleurs ouverts
öfene Brennern

G7F6E+FG1			
n.	3	3	
Ø mm	91,8	120,3	
kW	3	3,6	
Kcal/h	2.580	3.096	
BTU/h	10.236	12.283	

G7F6E+FG			
n.	3	3	120,3
Ø mm	91.8	120,3	
kW	3	3,6	
Kcal/h	2.580	3.096	
BTU/h	10.236	12.283	

G7F6E+T			
n.	3	3	
Ø mm	91.8	120,3	
kW	3	3,6	
Kcal/h	2.580	3.096	
BTU/h	10.236	12.283	

bruciatori forno
oven burners
brûleurs four
Brennern Backofen

n.	1		
kW	4		
Kcal/h	3.440		
BTU/h	13.648		

n.	1		
kW	7,8		
Kcal/h	6.708		
BTU/h	26.614		

n.	1		
kW	12		
Kcal/h	10.320		
BTU/h	40.944		

forno elettrico electric oven
four électrique Elektbackofen

potenza totale
total heat input
puissance totale
Gesamtleistung

kW	23,8		
Kcal/h	20.468		
BTU/h	81.205		

kW	27,6		
Kcal/h	23.736		
BTU/h	94.171		

kW	31,8		
Kcal/h	27.348		
BTU/h	108.502		

consumo gas
gas consumption
consommation gaz
Gasverbrauch

G 30/G31	kg/h	1,9	
G20	m ³ /h	2,5	
G25	m ³ /h	2,9	

G 30/G31	kg/h	2,1	
G20	m ³ /h	2,9	
G25	m ³ /h	3,4	

G 30/G31	kg/h	2,4	
G20	m ³ /h	3,3	
G25	m ³ /h	3,9	

connessione gas gas connection
raccordement gaz Gasanschluss

3/8" G

3/8" G

3/8" G

optional
option
Zubehör

accens. el. Fuochi - burners el. ign.
allum. el. brûleurs
Brennern elekt. Zündung

accens. el. Fuochi - burners el. ign.
allum. el. brûleurs
Brennern elekt. Zündung

accens. el. Fuochi - burners el. ign.
allum. el. brûleurs
Brennern elekt. Zündung

dim. camera forno
cavity dimensions
dimensions chambre
Abmessung Innenraum

mm 620x390x295h
n. 4 x 1/1 GN
(n. 4 x 600x400)

mm 685x550x295h
n. 4 x 2/1 GN

mm 1080x550x295h
n. 4 x 1/1 GN
(n. 4 x 1045x530)

dotazione griglie
grids supplies
fourniture de grilles
Mitgelieferte Roste

n. 1 x 600x400

n. 1 x 2/1 GN

n. 1 x 1045x530

peso totale total weight
poids total Gesamtgewicht

kg 118

kg 132

kg 153

cubatura cubic volume
volume Volumen

m³ 1,25

m³ 1,25

m³ 1,25

G7F6E+FG1
G7F6E+FG

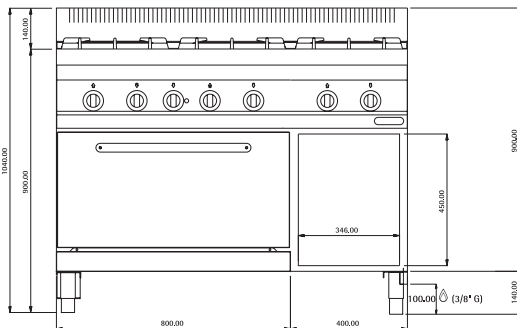

G7F6E+T

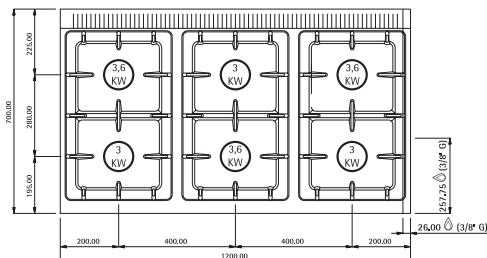
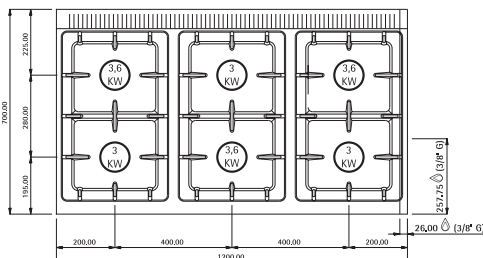
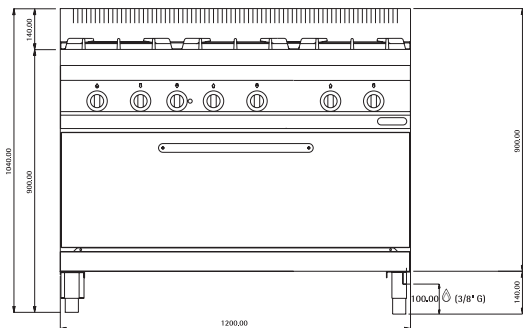

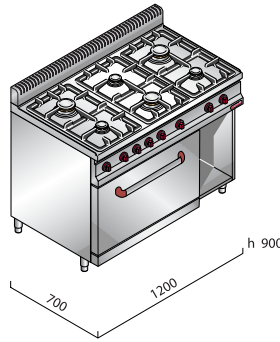
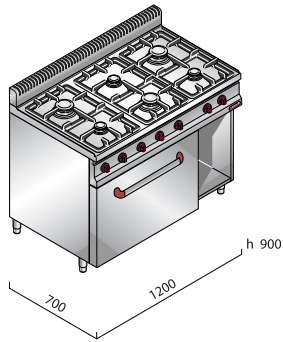

BERTO'S SPA®

Modello **model** modèle **Modell**

bruciatori aperti
open burners
brûleurs ouverts
öffene Brenner

G7F6E+FE1

n.	3	3
Ø mm	91,8	120,3
kW	3	3,6
Kcal/h	2.580	3.096
BTU/h	10.236	12.283

G7F6E+FE

n.	3	3
Ø mm	91.8	120,3
kW	3	3,6
Kcal/h	2.580	3.096
BTU/h	10.236	12.283

forno elettrico
electric oven
four électrique
Elektrobackofen

kW 3,5



kW 7,5



potenza totale
total heat input
puissance totale
Gesamtleistung

kW	19,8+3,5
Kcal/h	17.028
BTU/h	67.557

kW	19,8+7,5
Kcal/h	17.028
BTU/h	67.557

consumo gas
gas consumption
consommation gaz
Gasverbrauch

G 30/G31	kg/h	1,5
G20	m ³ /h	2,0
G25	m ³ /h	2,4

G 30/G31	kg/h	1,5
G20	m ³ /h	2,0
G25	m ³ /h	2,4

connessione gas **gas connection**
raccordement gaz **Gasanschluss**

3/8" G

3/8" G

connessione elettrica
electric connection
branchement électrique
elektrischer Anschluss

V 230 - 240 ~

V 400 - 415 3N ~

optional
option
Zubehör

accens. el. Fuochi - burners el. ign.
allum. el. brûleurs
Brennern elekt. Zündung

accens. el. Fuochi - burners el. ign.
allum. el. brûleurs
Brennern elekt. Zündung

dim. camera forno
cavity dimensions
dimensions chambre
Abmessung Innenraum

mm 620x390x295h
n. 4 x 1/1 GN
(n. 4 x 600x400)

mm 685x550x295h
n. 4 x 2/1 GN

dotazione griglie
grids supplies
fourniture de grilles
Mitgelieferte Roste

n. 1 x 600x400

n. 1 x 2/1 GN

peso totale **total weight**
poids total **Gesamtgewicht**

kg 124

kg 133

cubatura **cubic volume**
volume **Volumen**

m³ 1,25

m³ 1,25

G7F6E+FE1
G7F6E+FE

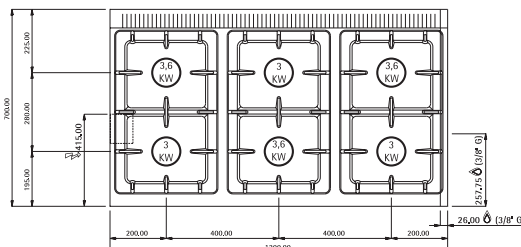
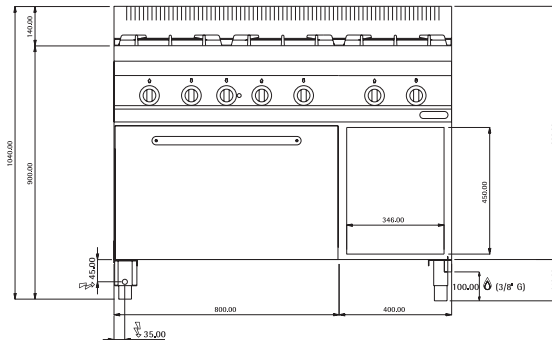

Macros 700 cooking ranges

